

TERRASSE

Add.: Furkat 2A, Shaykhontokhur district,
Tashkent city, Republic of Uzbekistan
Tel.: +99899 887 8686
+99899 787 8686
E-mail: terrasseuz@gmail.com
Web: www.terrasse.uz

TERRASSE

WPC

WPC DECKING
WPC CLADDING
WPC FENCE & RAILING
WPC LOUVER & GRILLES

TERRASSEWPC

Extensive experience in the wood-plastic composite (WPC) industry. Professional and ample production and also research capabilities for all customer needs. Providing consumers high-quality solutions for interior and exterior of the house.

TERRASSEWPC

Большой опыт в сфере древесно-полимерных композитов (ДПК). Профессиональные и достаточные производственные, а также научно-исследовательские возможности для удовлетворения всех потребностей клиентов. Предоставление потребителям высококачественных решений для интерьера и экстерьера дома.

TERRASSEWPC

The product adopts multi-layer composite technology for one-time molding. Outer layer is fully covered with a dense and evenly distributed polymer composite protective shield. Inner layer is composed of natural wood and other polymer additives for the product processing.

TERRASSEWPC

В продукции используется многослойная композитная технология разового формования. Внешний слой продукта полностью покрыта плотной и равномерно распределённой полимерной композитной защитной оболочкой. Внутренний слой состоит из натуральной древесины, а также других полимерных добавок для обработки продукта.

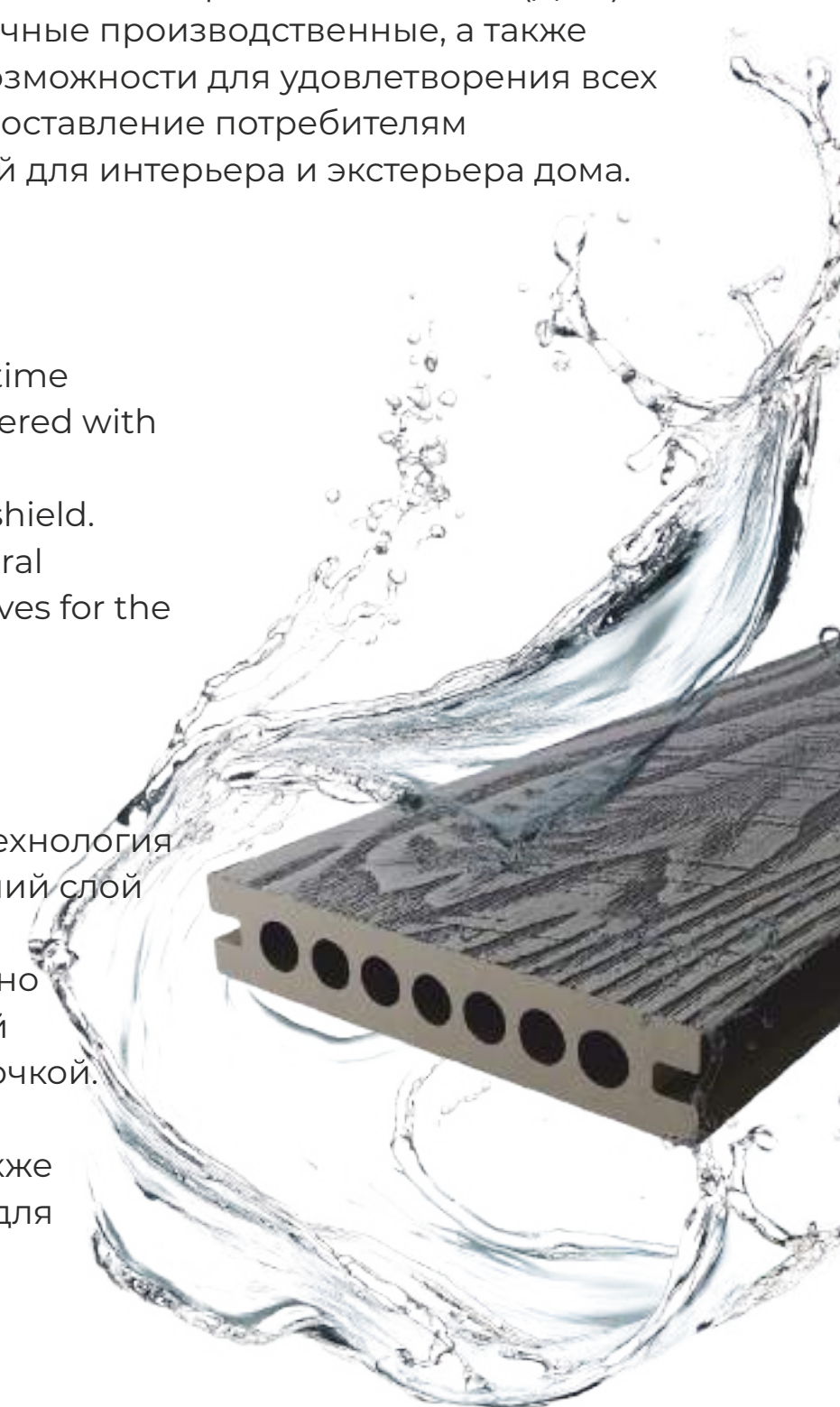

Protection Against Termite and Insects

No need to worry about the appearance of termite or other insects, the product offering long-term protection and stability

Защита от термитов и насекомых

Не беспокойтесь о появлении термитов или других насекомых, продукт обеспечивает долгосрочную защиту и стабильность

Eco-Friendliness and Reliability, without Harmful Substances

The product is free from formaldehyde, benzene, and other volatile organic compounds, ensuring a healthy and safe environment for you and your family

Экологичность и надёжность, без вредных веществ

Продукт не содержит формальдегид, бензол и другие летучие органические соединения, гарантируя здоровую и безопасную среду для вас и вашей семьи

Quality Assurance up to 25 Years, Long-Term Reliability

Enjoy high-quality of WPC, ensuring long service life of your product

Гарантия качества до 25 лет, долговечная надёжность

Наслаждайтесь высоким качеством ДПК, обеспечивающий долгий срок службы вашего продукта

Realistic Wood Texture, Closer to Nature

The refined wood pattern gives a feeling of touch with nature in every movement

Реалистичная текстура дерева, ближе к природе

Тонкий древесный узор дарит ощущение прикосновения к природе в каждом движении

“Zero” Water Absorption, Protection Against Mold and Fungus

Complete protection against water absorption effectively preventing the formation of mold and fungus for a long-term operation

“Нулевое” водопоглощение, защита от плесени и грибка

Полная защита от впитывания воды эффективно предотвращает образование плесени и грибка для долговременной эксплуатации



WPC DECKING

Decking is a practical and stylish WPC product, with a variety of textures and colors of natural wood. **WPC Decking** consists of the following series: ARABELLA (1st generation), BLAZER (1st generation), VANTAGE (2nd generation), GILBERT (2nd generation), step DENZEL (2nd generation), ELEMENTO (3rd generation) and L-Shaped Corner Trim. **WPC Decking** perfectly tolerates precipitation, does not swell from moisture, does not rot, or dry out during operation, retains its color for many years, resistance to heat and frost (from -50°C to +70°C), has a high durability.

Террасная доска — это практичный и стильный продукт из ДПК, с разнообразными фактурами и цветами натуральной древесины. **Террасная доска из ДПК** состоит из следующих серий: ARABELLA (1-поколение), BLAZER (1-поколение), VANTAGE (2-поколение), GILBERT (2-поколение), step DENZEL (2-поколение), ELEMENTO (3-поколение), а также L-образного углового профиля. **Террасная доска из ДПК** отлично переносит осадки, не разбухает от влаги, не гниет, не рассыхается при эксплуатации, сохраняет свой цвет на долгие годы, устойчива к жаре и морозам (от -50 °C до + 70 °C), имеет высокую износостойкость.

WPC DECKING TEXTURE



COLORS



WPC DECKING
1st GENERATION

ARABELLA

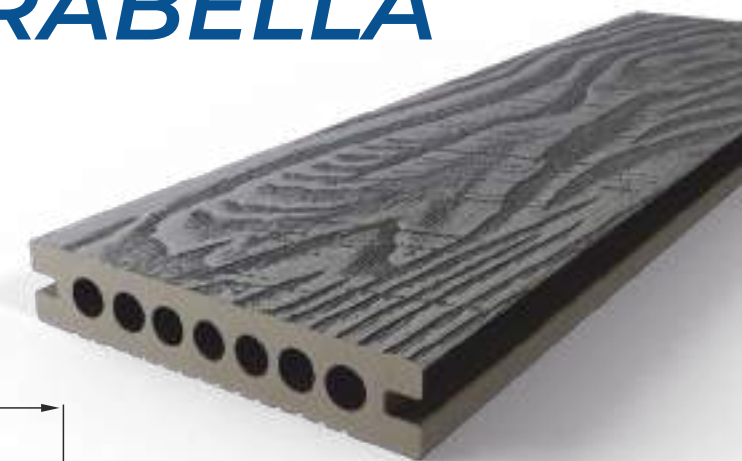

SPECIFICATION

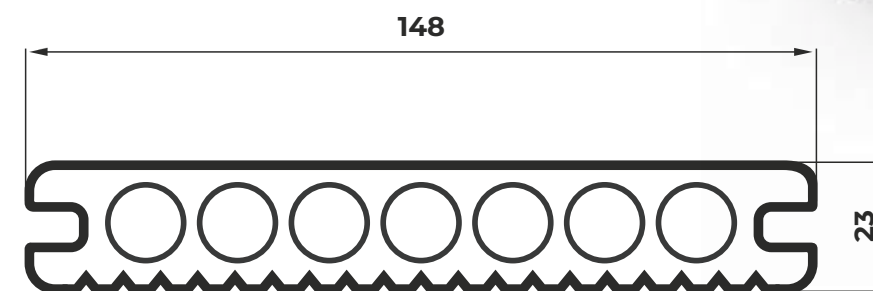



WPC DECKING
1st GENERATION

BLAZER



SPECIFICATION

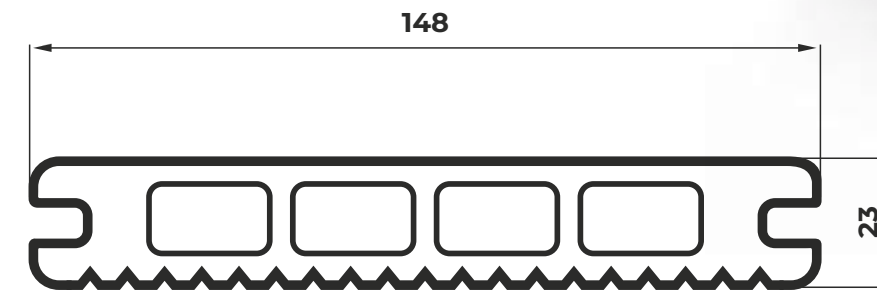



WPC DECKING
2nd GENERATION

VANTAGE

SHIELD

CORE

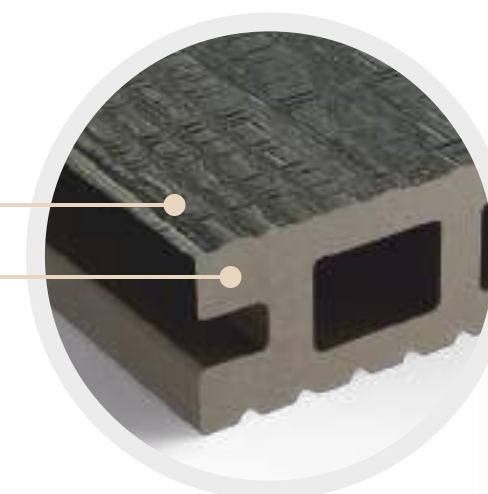

SPECIFICATION

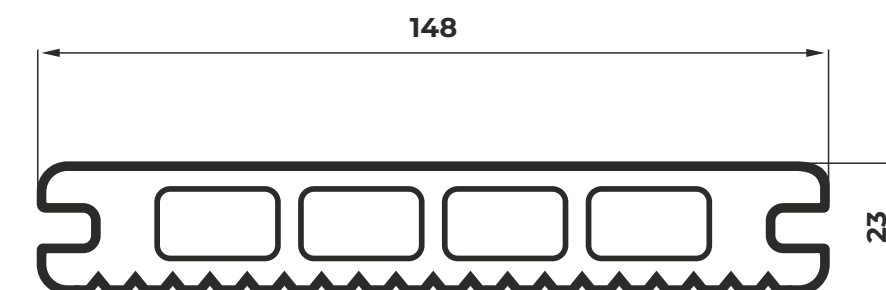

WPC DECKING
2nd GENERATION

GILBERT

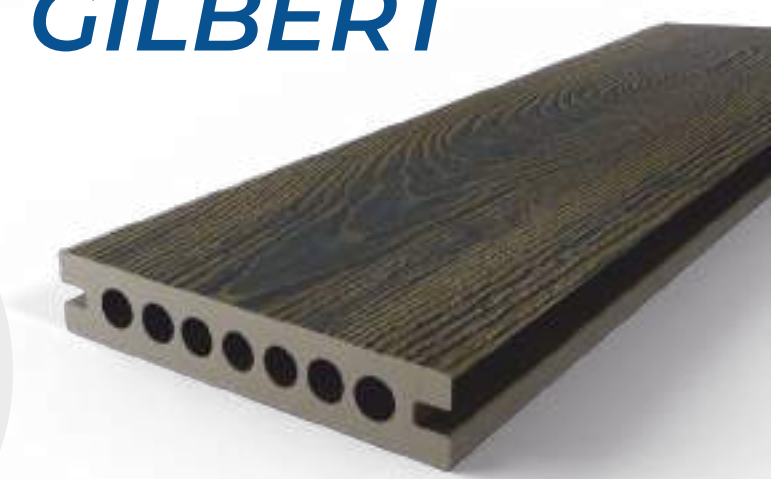
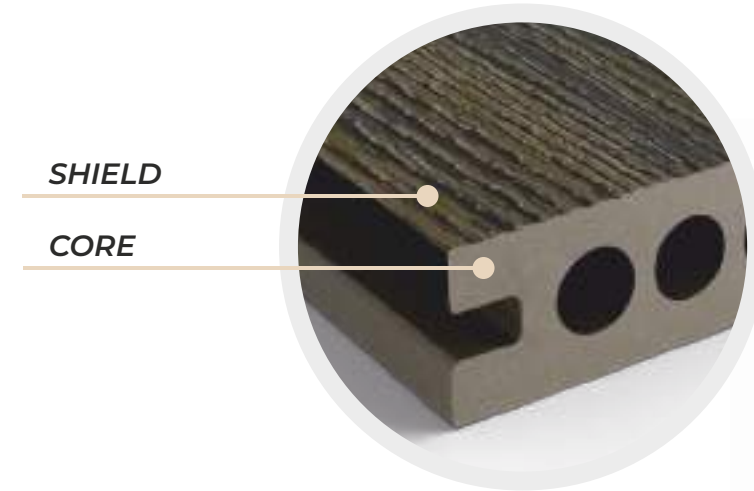

SPECIFICATION

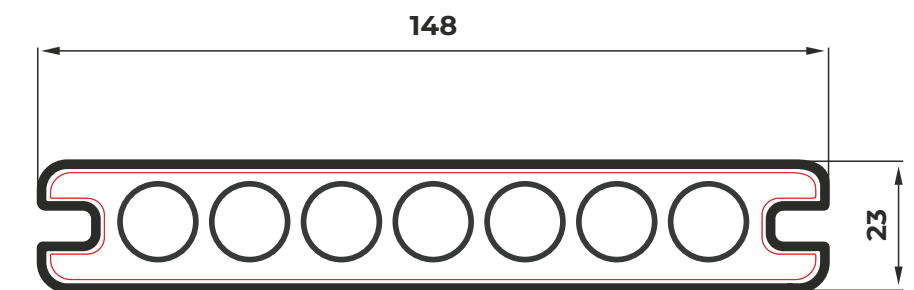

WPC DECKING
2nd GENERATION

step DENZEL

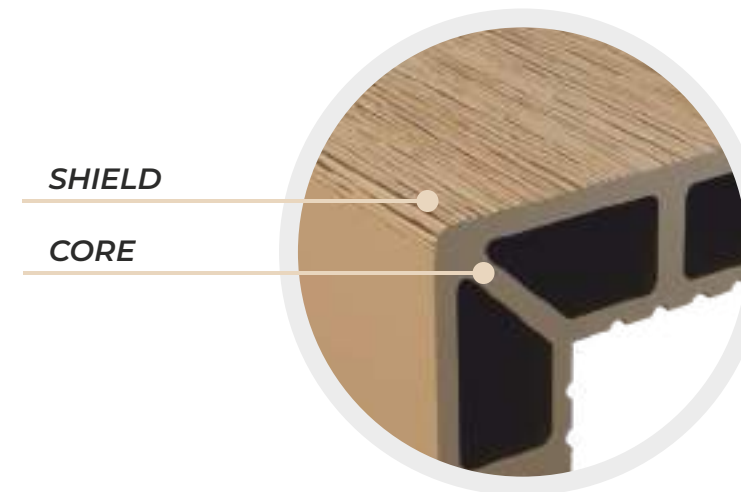

SPECIFICATION

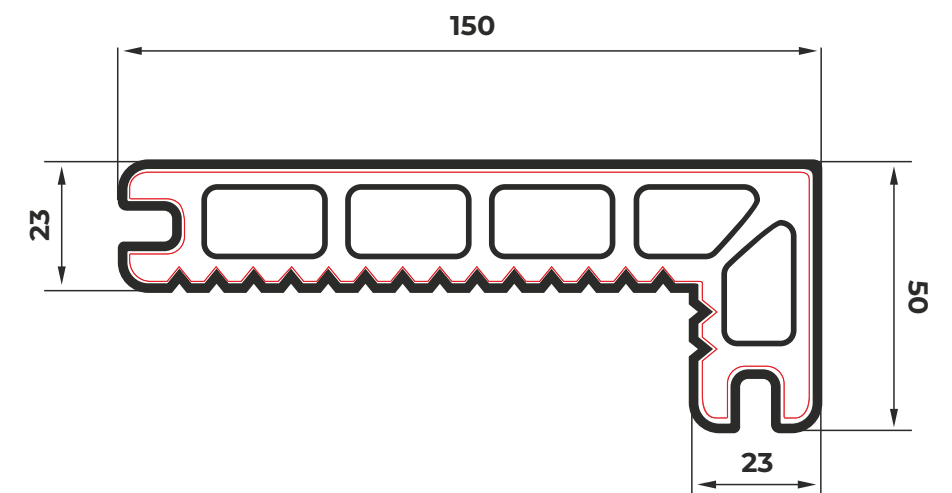

WPC DECKING
3rd GENERATION

ELEMENTO

SHIELD

CORE

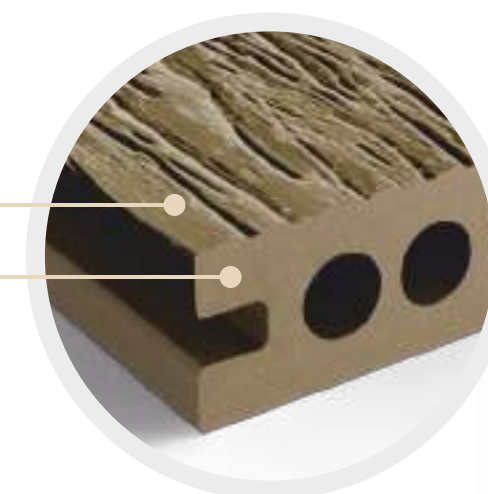

SPECIFICATION

148

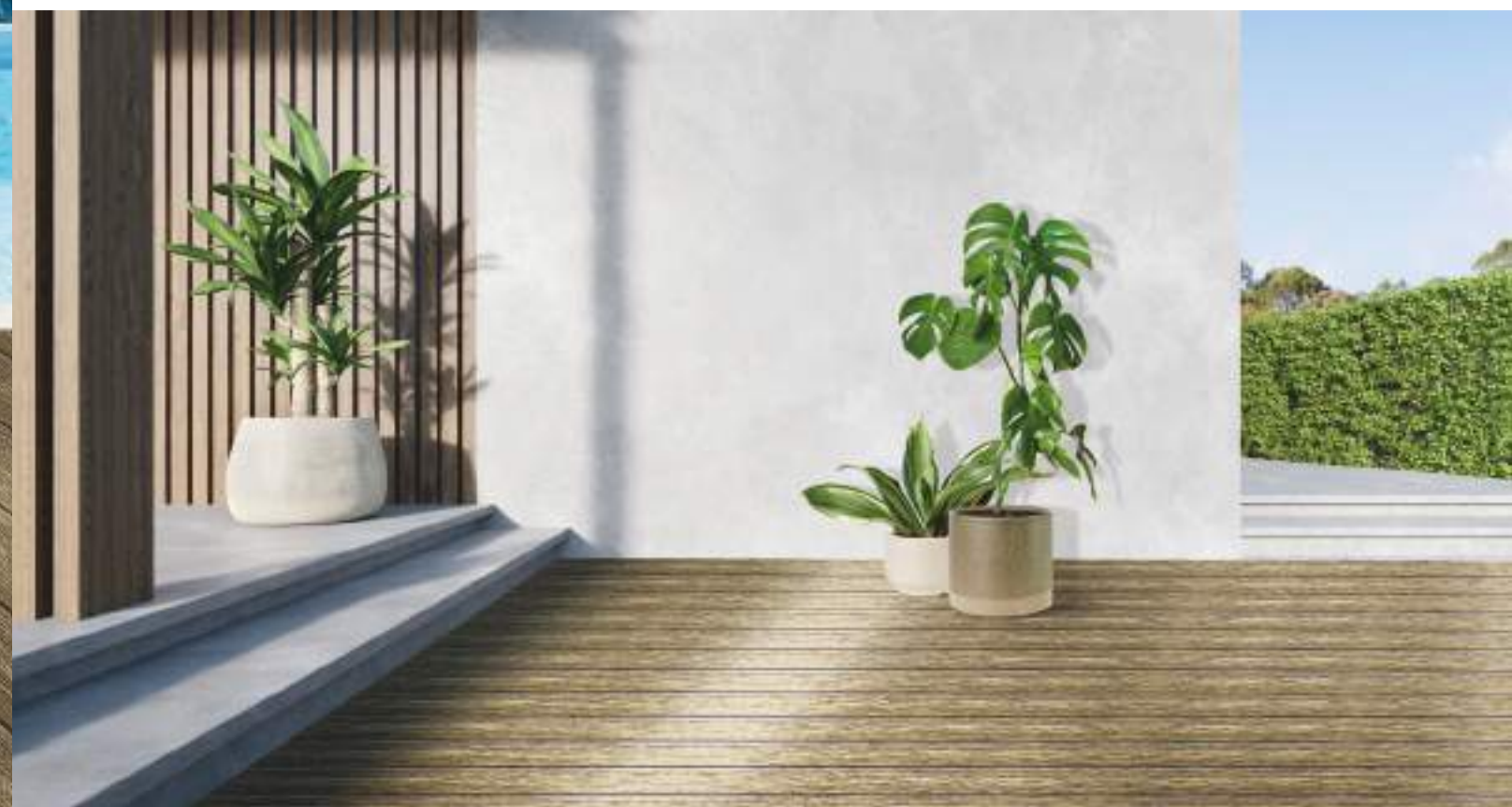
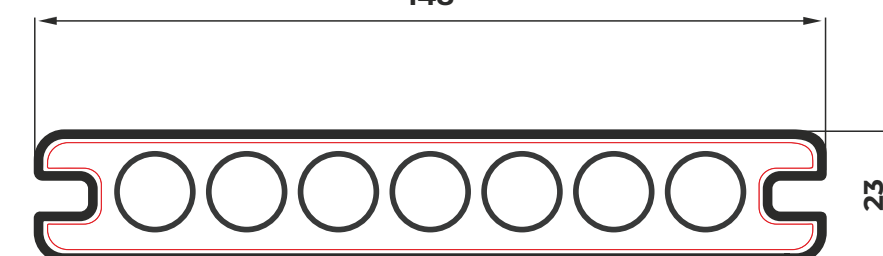

WPC DECKING ACCESSORIES



Stainless Steel Start Clip



Plastic Clip



Stainless Steel Clip

Co-extrusion L-Shaped
Corner Trim: 50mm*50mm



INSTALLATION GUIDE



1. First deck installing with
Stainless Steel Start Clip



2. Then other decks
attaching to each other
with Stainless Steel Clip
or Plastic Clip

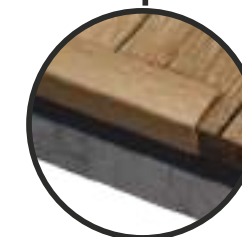

3. At the end covering the edge
of decks with L-Shaped Corner Trim



WPC DECKING TILES

WPC Decking Tiles will allow you to quickly improve your house (garden paths, flooring on verandas, in gazebos and on balconies). This coverage can be installed on any flat surface. **WPC Decking Tiles** allows you to move comfortably throughout the house even in bad weather and retains its appearance for a long time without special care.

Садовый паркет из ДПК позволит вам быстро благоустроить ваш дом (садовые дорожки, настилы на верандах, в беседках и на балконе). Это покрытие может укладываться на любую ровную поверхность. **Садовый паркет из ДПК** позволяет удобно передвигаться по всей территории дома даже в непогоду, сохраняя свой внешний вид на долгое время без особого ухода.



WPC DECKING TILES
2nd GENERATION



SPECIFICATION

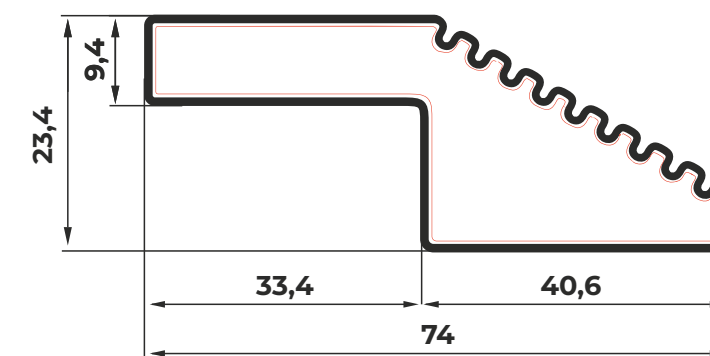
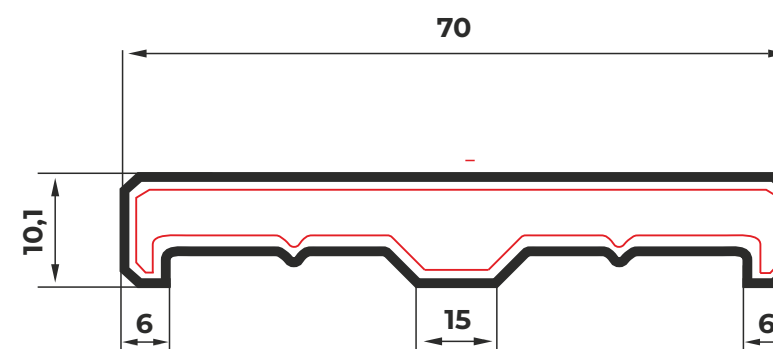

30x30cm

30x60cm

30x90cm

ACCESSORIES

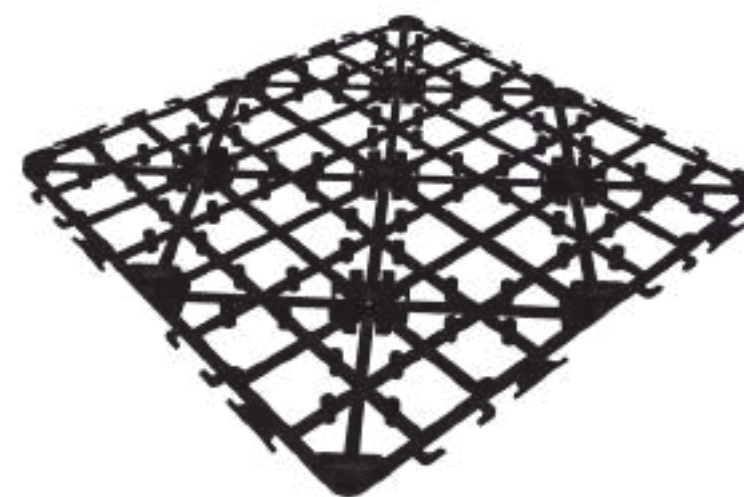

4 sides locking base



Border locking base



WPC CLADDING

Castellated and Slatted WPC Cladding combine durability, elegance and stylish design, making them an excellent solution for outer and inner cladding. This innovative product covered with protective layer, which provides maximum protection from exposure to ultraviolet radiation.

Фасадные стеновые и декоративные реечные панели из ДПК гармонично сочетают в себе прочность, элегантность и стильный дизайн, что делают их отличным решением для наружной и внутренней облицовки стен и потолка. Этот инновационный продукт имеет верхний защитный слой, который обеспечивает максимальную защиту от воздействия ультрафиолетового излучения.



WPC CLADDING



INFINITY
(MS-T001)



ALMOND
(MS-T002)



CENTURY
(MS-T003)



DAYTONA
(MS-T004)



MARINE
(MS-T005)



DESERT
(MS-T006)



IMOLA
(MS-T007)



SELENITE
(MS-T008)



ALPINE
(MS-T009)



BOHEMA
(MS-T010)

COLORS



POLAR WHITE
(MS-C001)



MID BLACK
(MS-C002)



SPACE GREY
(MS-C003)



AVORIO
(MS-C004)



ASH BROWN
(MS-C005)



NARDO GREY
(MS-C006)

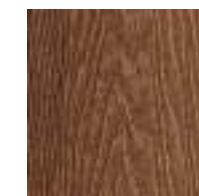

MACAO BROWN
(MS-C007)



DUSK
(MS-C008)



CAMEL
(MS-C009)



SLATE
(MS-C010)



SAND
(MS-C011)

WPC CLADDING
2nd GENERATION

CASTELLATED CLADDING

SPECIFICATION

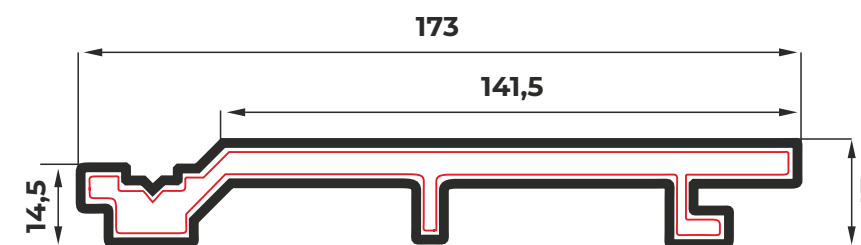



TERRASSE
WPC

WPC CLADDING 2nd GENERATION

SINGLE-COLOR
SLATTED CLADDING

SPECIFICATION

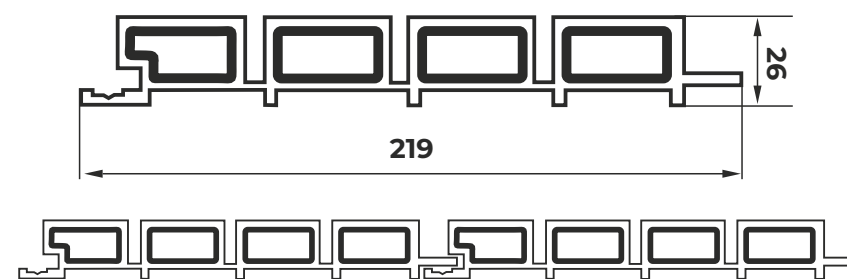



TERRASSE
WPC

MULTI-COLOR
SLATTED CLADDING

WPC CLADDING 2nd GENERATION

SPECIFICATION

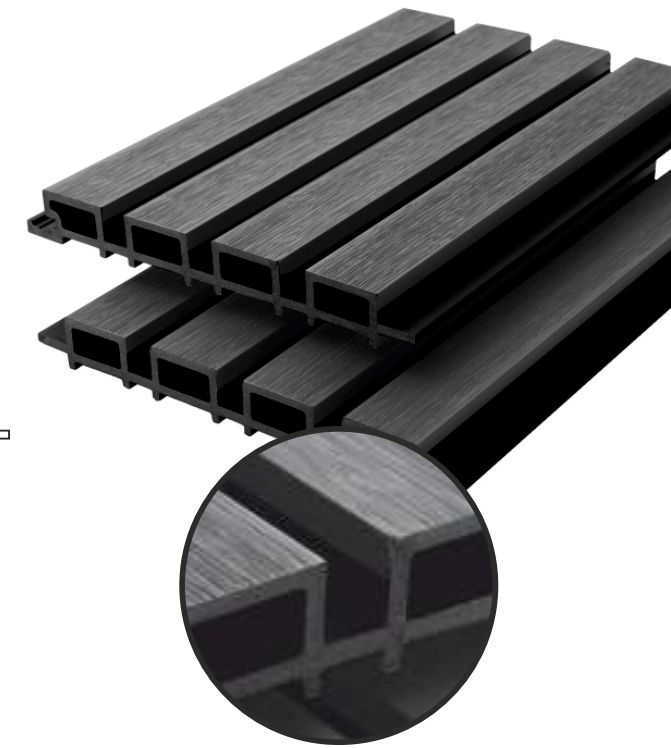
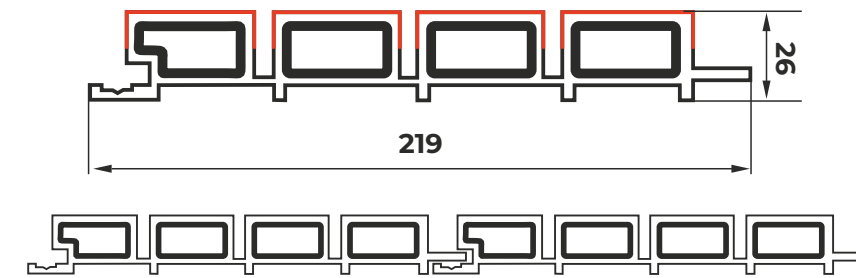

WPC CLADDING ACCESSORIES

WPC Cross-sectional Diagram:
49mm*49mm

WPC L-Shaped Corner Trim:
50mm*50mm

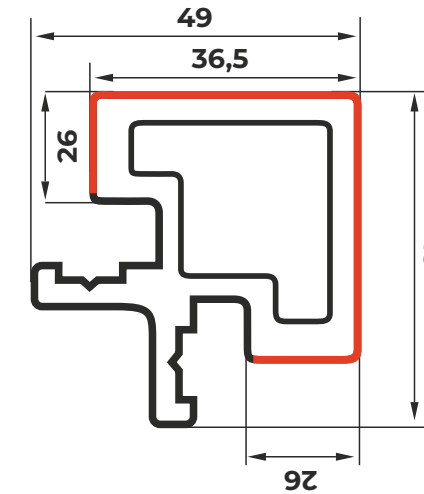

INSTALLATION GUIDE

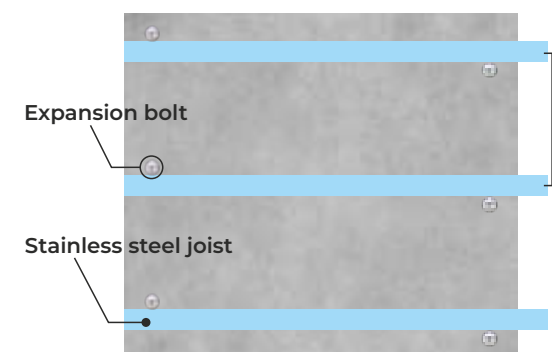

1. Install the joist, the center distance will not exceed 500mm.

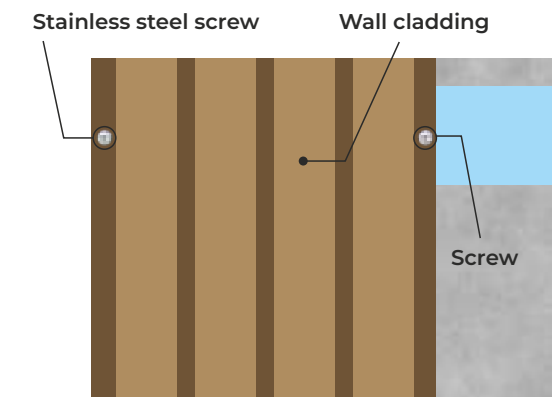

2. Fix the first cladding board to the joist with screw

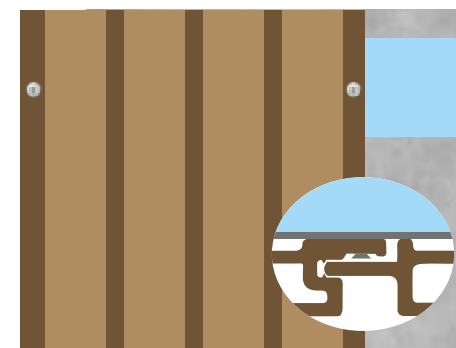

3. Install other wall cladding in order

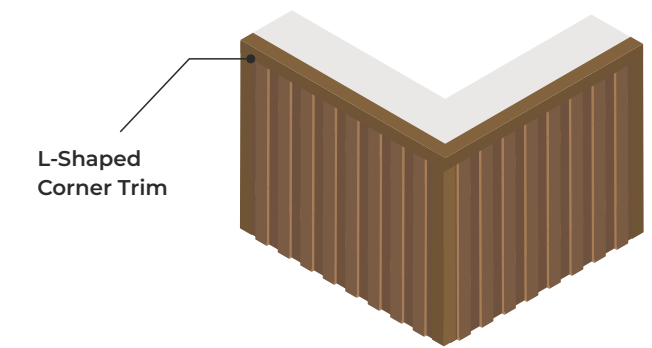

4. Install the L-Shaped Corner Trim with Screws and complete the installation

WPC FENCE

WPC Fence is a stylish and practical solution for your house. Wooden, metal or brick fences are no longer in strong demand nowadays. **WPC Fence** will look great and retain its original appearance for many years. In comparison with wooden, metal or brick fences, **WPC Fence** has several advantages: durability and longevity, no need for painting and processing, does not rot, fade and crack.

Заборная доска из ДПК — это стильное и практичное решение для вашего дома. Заборы из дерева, металла или кирпича на сегодняшний день уже не пользуются сильным спросом. **Заборная доска из ДПК** будет прекрасно выглядеть и сохранит свой первоначальный вид на долгие годы. **Заборная доска из ДПК** по сравнению с заборами и ограждениями из дерева, металла или кирпича обладает рядом преимуществ: износостойчивость и долговечность, не нуждается в покраске или обработке, не гниет, не выцветает и не растрескивается.



WPC FENCE



INFINITY
(MS-T001)



ALMOND
(MS-T002)



CENTURY
(MS-T003)



DAYTONA
(MS-T004)



MARINE
(MS-T005)



DESERT
(MS-T006)



IMOLA
(MS-T007)



SELENITE
(MS-T008)



ALPINE
(MS-T009)



BOHEMA
(MS-T010)

COLORS



POLAR WHITE
(MS-C001)



MID BLACK
(MS-C002)



SPACE GREY
(MS-C003)



AVORIO
(MS-C004)

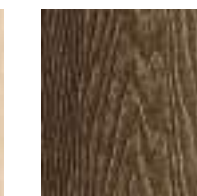

ASH BROWN
(MS-C005)



NARDO GREY
(MS-C006)



MACAO BROWN
(MS-C007)



DUSK
(MS-C008)

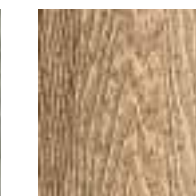

CAMEL
(MS-C009)

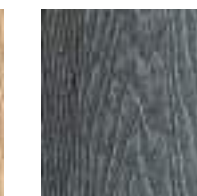

SLATE
(MS-C010)



SAND
(MS-C011)

WPC FENCE

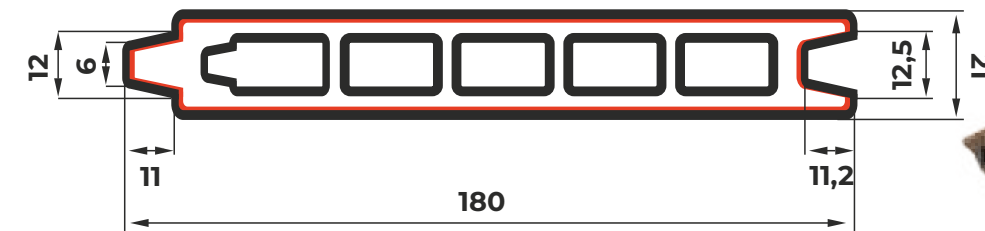

FENCE STYLE

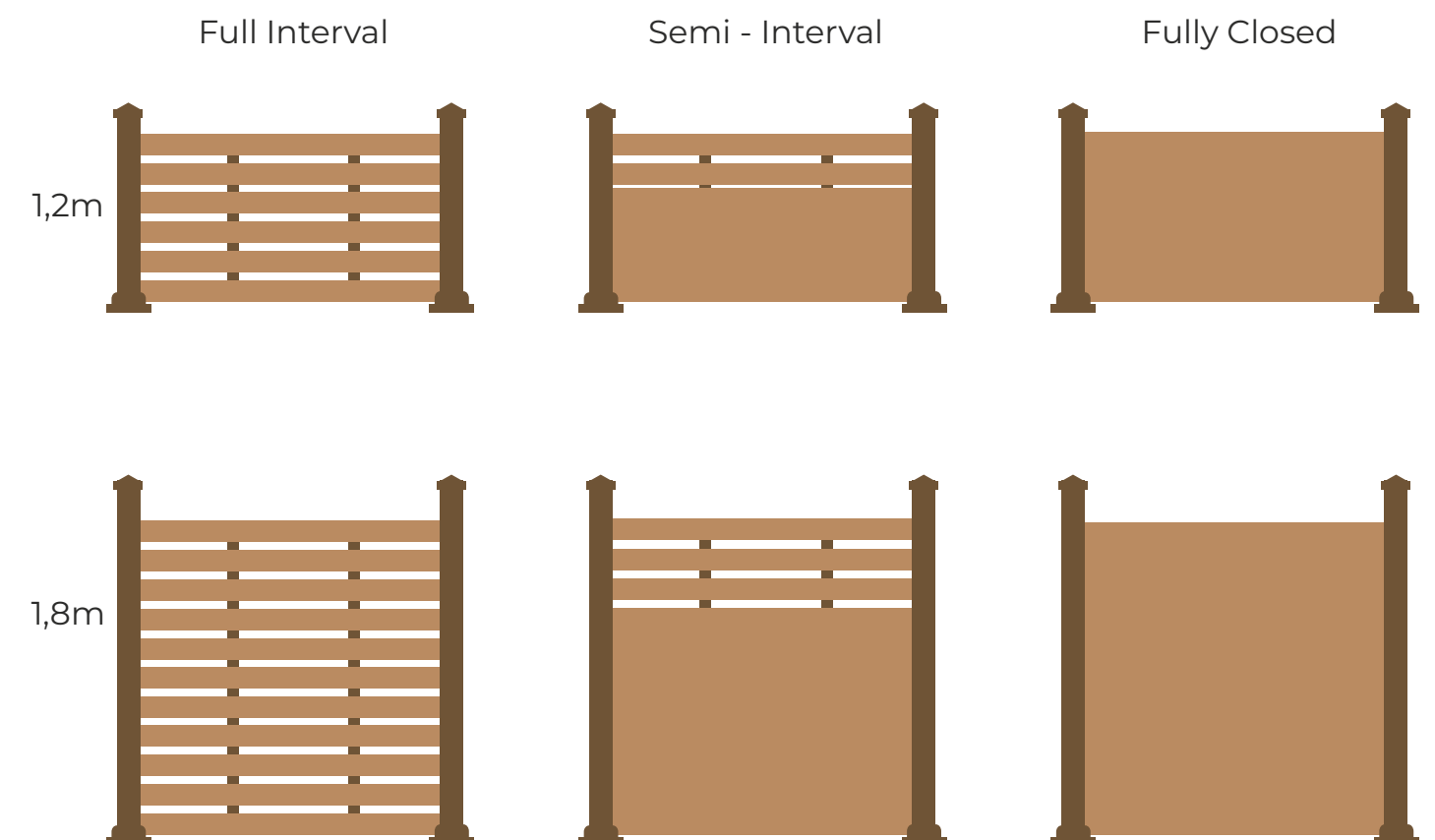

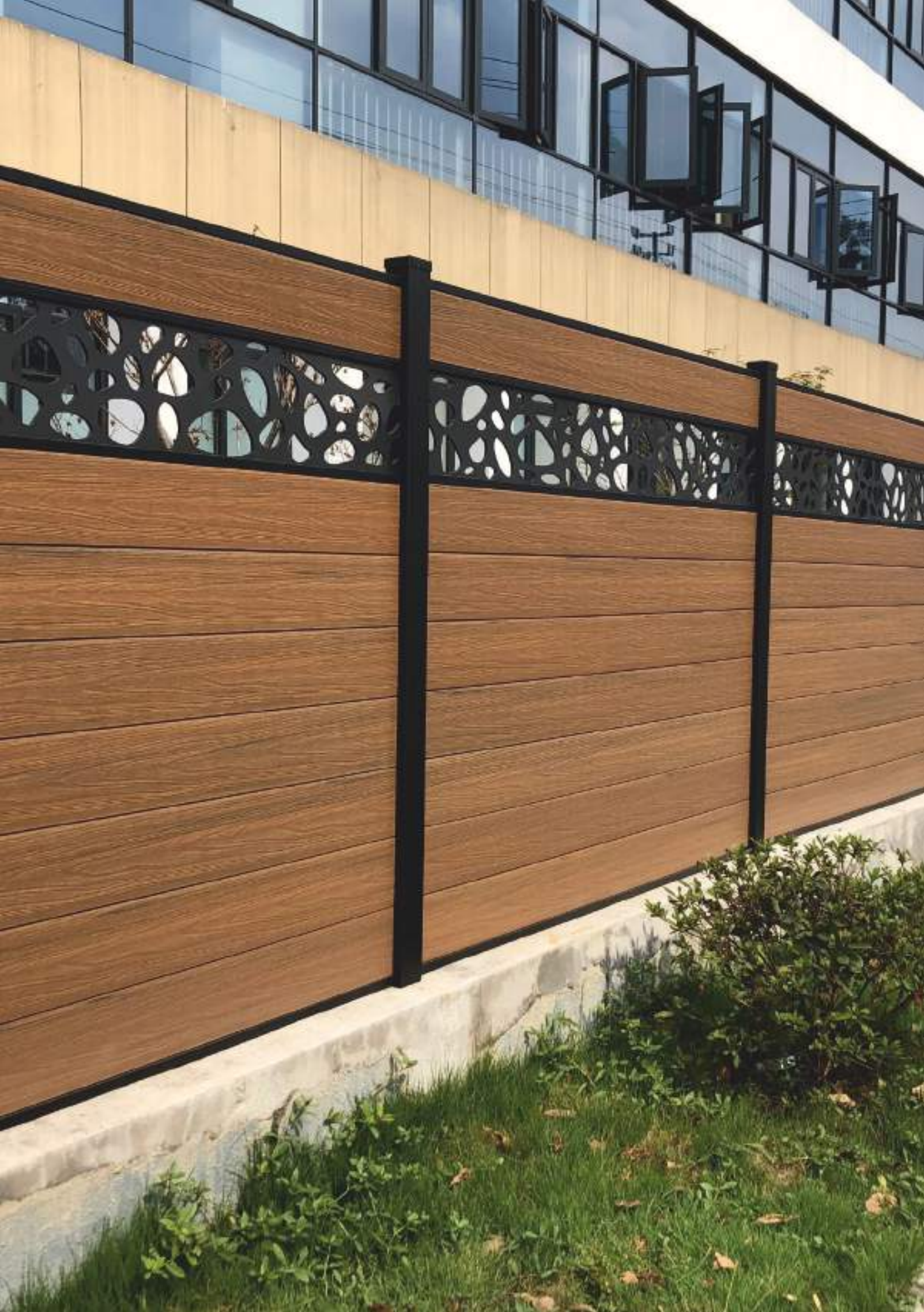

WPC FENCE ACCESSORIES

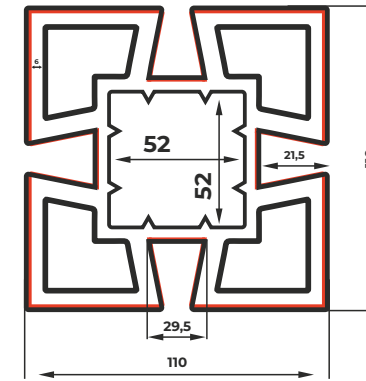

WPC Post: 110mm*110mm



Plastic Post Cap
110mm*110mm



Plastic Base Cover
110mm*110mm



Plastic Division Bar

INSTALLATION GUIDE

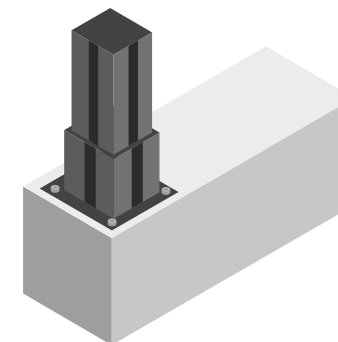

1. Fix the post on the mounted post base with self-drilling screws.

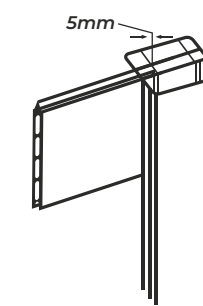

2. Note: No less than 5mm expansion gap is important between the fence panel and the post.

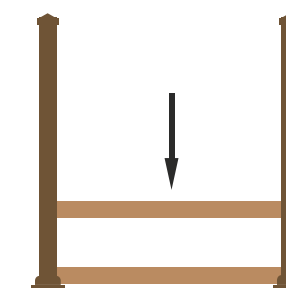

3. Slot the fence panels between posts.

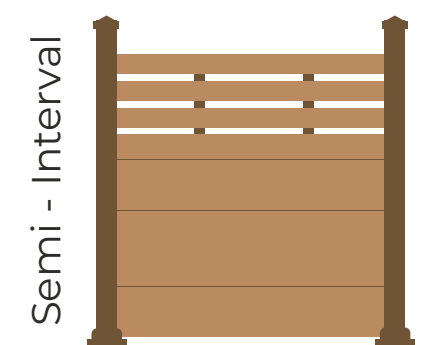

Semi - Interval

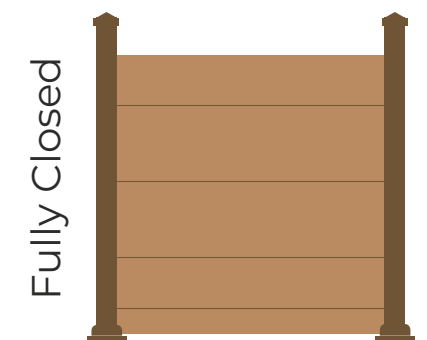

Fully Closed

4. Job done!



WPC RAILING

WPC Railing is the perfect solution for any terrace, veranda, porch, staircase, balcony, gazebo, summer playground, café and restaurant. Advantages of the **WPC Railing** are aesthetics, durability and longevity, different realization options. It has properties that the railing does not fade and deform due to temperature differences. **WPC Railing** maintain its aesthetic appeal over 25 years, and does not require painting and processing.

Террасные ограждения из ДПК – это идеальное решение для любой террасы, веранды, крыльца, лестницы, балкона, беседки, летней площадки, кафе и ресторана. Преимущества **террасных ограждений из ДПК**: эстетичность, прочность и долговечность, различные варианты исполнения. Они обладают свойствами, благодаря которым ограждения не выцветают и не деформируются из-за перепада температур. **Террасные ограждения из ДПК** свыше 25 лет сохраняют эстетическую привлекательность, не требуют покраски и обработки.

WPC RAILING

COLORS



POLAR WHITE
(MS-C001)



MID BLACK
(MS-C002)



SPACE GREY
(MS-C003)



AVORIO
(MS-C004)



ASH BROWN
(MS-C005)



NARDO GREY
(MS-C006)

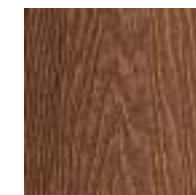

MACAO BROWN
(MS-C007)



DUSK
(MS-C008)



CAMEL
(MS-C009)



SLATE
(MS-C010)



SAND
(MS-C011)



WPC RAILING

SPECIFICATION

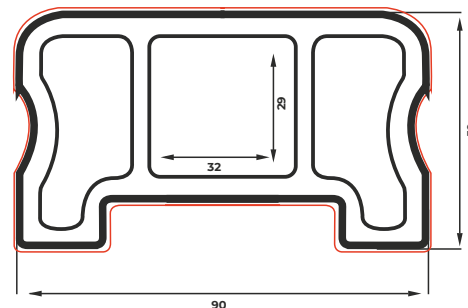
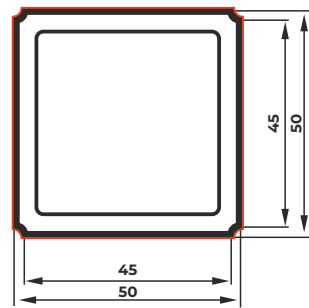
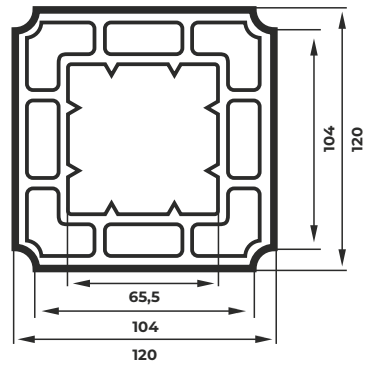

WPC Post



WPC Baluster



WPC Rail

RAILING STYLE

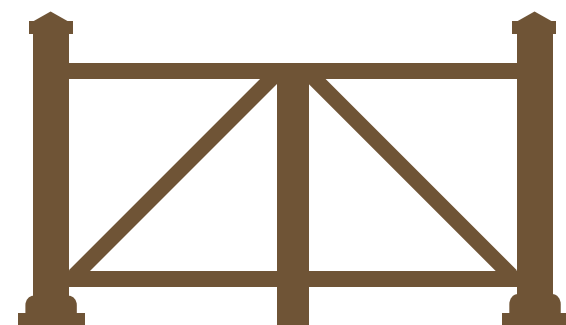

WPC RAILING ACCESSORIES



Plastic Post Cap
120mm*120mm



Plastic Base Cover
120mm*120mm



Plastic Rail Connector:
90mm*60mm



Plastic Baluster Connector:
40mm*40mm

INSTALLATION GUIDE

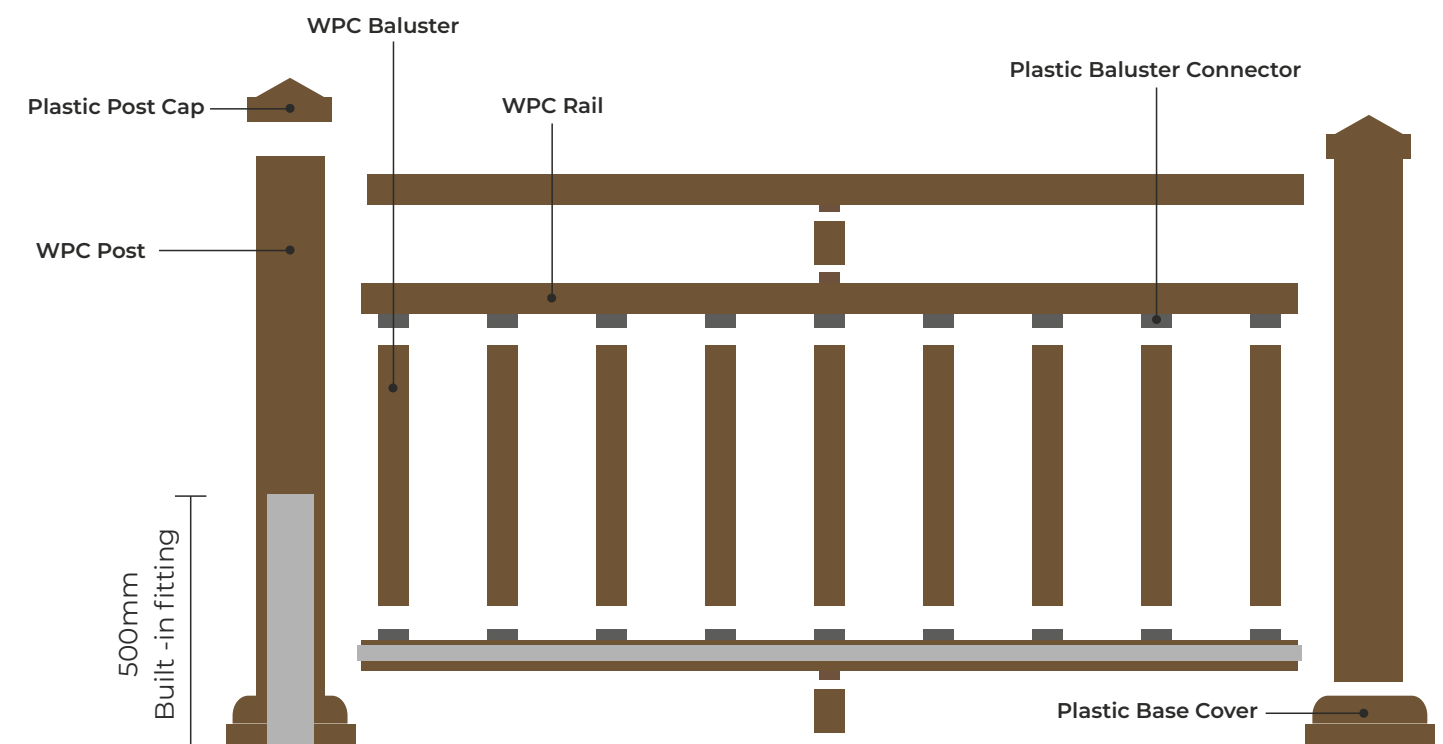

WPC LOUVER & GRILLES

WPC Louver & Grilles are the latest solutions that have recently become very popular. They are very easy to install, require no special maintenance, have a unique visual appearance, and have a long service life. They can be used in both interior and exterior of any building or construction. **WPC Louver & Grilles** withstand harsh weather conditions well and retain their original appearance for a long time.

Реечные перегородки и потолки из ДПК — это самое новое решение за последнее время, которое начало пользоваться большой популярностью. Они очень просты в установке, не требуют особого ухода, визуально выглядят необычно и имеют большой срок службы. Можно применять их как в интерьере, так и в экстерьере любого здания или сооружения. **Реечные перегородки и потолки из ДПК** хорошо переносят плохие погодные условия и надолго сохраняют свои первоначальные виды.

WPC LOUVER & GRILLES

COLORS



POLAR WHITE
(MS-C001)



MID BLACK
(MS-C002)



SPACE GREY
(MS-C003)



AVORIO
(MS-C004)



ASH BROWN
(MS-C005)



NARDO GREY
(MS-C006)

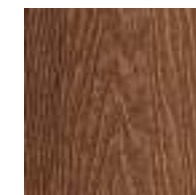

MACAO BROWN
(MS-C007)



DUSK
(MS-C008)



CAMEL
(MS-C009)



SLATE
(MS-C010)



SAND
(MS-C011)



WPC LOUVER & GRILLES

SPECIFICATION

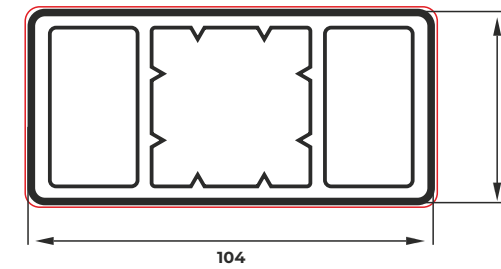

INSTALLATION GUIDE

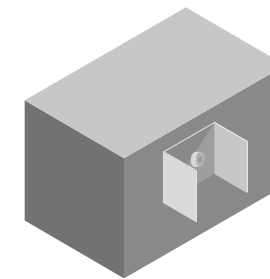

1. Fix the metal clip with expansion screws.

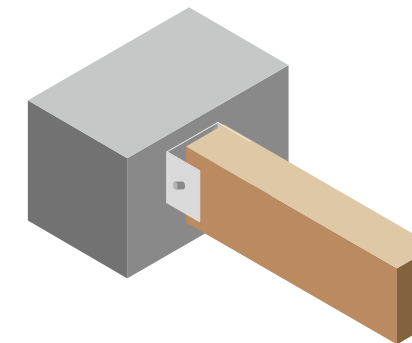

2. Put the square tube in the metal clip and fix it with screws.

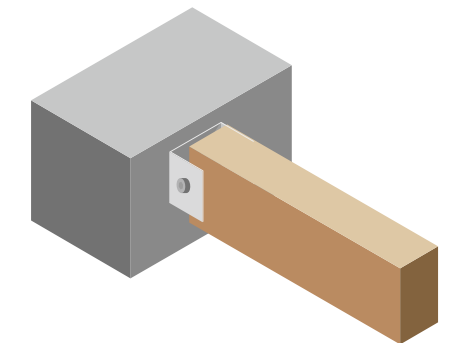

3. The installation is complete

