



GCE METAL





GCE METAL

Ürün Katalođu
Product Catalogue

1. Casting / Döküm

Precision starts at the mold. At GCE Metal, we cast with excellence, transforming raw metals into components of unmatched integrity. Our advanced techniques ensure durability, consistency, and superior quality in every piece. Crafted to perform, built to last.

Hassasiyet kalıpta başlar. GCE Metal olarak, ham metalleri yüksek kaliteyle dönüştürerek eşsiz bütünlükte parçalar üretiriz. Gelişmiş döküm tekniklerimizle dayanıklılık, tutarlılık ve kaliteyi garanti ederiz. Performans için üretilir, uzun ömür için tasarlanır.

2. Forging / Dövme

Strength is forged, not born. At GCE Metal, we shape metals under extreme force to achieve unmatched toughness and structural reliability. Our forging processes deliver components that thrive in the most demanding environments. Engineered for power, made for endurance.

Güç doğmaz, dövülerek şekillenir. GCE Metal'de metalleri yüksek basınçla şekillendirerek olağanüstü dayanıklılık ve güvenilirlik sağlarız. Dövme işlemlerimiz, en zorlu koşullarda bile üstün performans gösteren parçalar üretir. Güç için tasarlandı, dayanıklılık için üretildi.

3. Galvanizing / Galvanizleme

Protection that lasts. Our galvanizing solutions provide long-term resistance against corrosion, ensuring your components stay strong and reliable for years. At GCE Metal, we coat with care and precision. Because surface protection is just the beginning of true durability.

Uzun ömürlü koruma. Galvanizleme çözümlerimiz, korozyona karşı üstün direnç sağlayarak parçalarınızı yıllarca güçlü ve güvenilir kılar. GCE Metal'de yüzey kaplamayı titizlik ve hassasiyetle yaparız. Çünkü gerçek dayanıklılık, yüzeyde başlar.

4. Innovation / İnovasyon

Tomorrow starts with today's ideas. At GCE Metal, innovation drives everything we do—from smarter manufacturing to future-ready materials. We invest in technology and talent to stay ahead in a changing world. Progress is not an option—it's our mission.

Yarın, bugünün fikirleriyle başlar. GCE Metal'de inovasyon, üretimden malzemeye kadar her adımda itici gücümüzdür. Teknolojiye ve insan kaynağına yatırım yaparak değişen dünyaya yön veririz. Gelişim bizim için bir tercih değil, bir görevdir.

5. Sustainability / Sürdürülebilirlik

Built for the future. We believe that true strength lies in responsibility—our sustainable practices reduce waste, optimize resources, and respect the planet. At GCE Metal, we engineer with tomorrow in mind. Green thinking, steel strength.

Gelecek için üretiyoruz. Gerçek gücün sorumlulukla geldiğine inanıyoruz—sürdürülebilir uygulamalarımızla atıkları azaltıyor, kaynakları verimli kullanıyor ve doğaya saygı gösteriyoruz. GCE Metal olarak yarını düşünerek mühendislik yapıyoruz. Yeşil düşünce, çelik gibi güç.



BELGELLER

ISO 9001:2015
ISO 10002:2018
ISO 14001:2015
ISO 45001:2018



GCE METAL

ÜRÜNLER | PRODUCTS

Ringlock Scaffolding Systems
Flanşlı İskele Sistemleri

1-2

Pages

Cuplock Scaffolding Systems
Kamalı (Cuplock) İskele Sistemleri

3

Pages

H Type (Modular) Scaffolding Systems
H Tipi (Modüler) İskele Sistemleri

4

Pages

Couplers
Kelepçeler

5-6

Pages

Formwork Frame Panel Accessories
Kalıp Çerçeve Paneli Aksesuarları

7-8

Pages

Base Head Jacks
Taban Başlı Krikolar

9-10

Pages

Slope Nut&Forged Bars
Eğimli Somun Ve Dövme Çubuklar

11-12

Pages

Other Formwork
Diğer Kalıplar

13

Pages

Water Stops
Su Tutucu

14

Pages

Prop Nuts
Somunlar

15-16

Pages

Timber Beam Formwork Accessories
Ahşap Kiriş Kalıp Aksesuarları

17-18

Pages

Ringlock Scaffolding Systems

Flanşlı İskele Sistemleri



B0617
M12 Bolt+22mm
M12 Cıvata+22mm
Steel / Çelik
0.65kg



B0681
Flange Ledger End
Sabitleme Flanşı
Forged/ Dövme
1.25kg



B0148
Left Ledger End
Çapraz Kurtağzı Sol
Ductile / Sfero
0.49kg



B0548
Flange Laser St52 10mm
Flanş Lazer St52 10mm
Sheet Steel / Sac Çelik
0.49kg



B0147
Right Ledger End
Çapraz Kurtağzı Sağ
Ductile / Sfero
0.49kg



B0301
Flange Press St37 8mm
Flanş Pres St37 8mm
Sheet Steel / Sac Çelik
0.41kg



B0539
Flange Laser St37 8mm
Flanş Lazer Kesim St37 8mm
Sheet Steel / Sac Çelik
0.42kg



Ringlock Scaffolding Systems

Flanşlı İskele Sistemleri

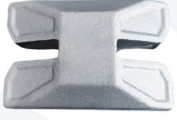

B0629
Double Ledger End
Without Wedge

Çiftli Kurtağzı Kamasız
Ductile / Sfero
0.90kg



B0515
Double Ledger End
With Wedge

Çiftli Kurtağzı Kamalı
Ductile / Sfero
1.14kg

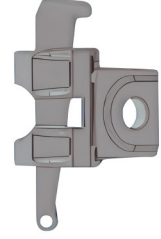

B0627
Ledger End Left And
Right With Wedge

Çapraz Kurtağzı Kamalı
Ductile / Sfero
0.60kg



B0562
Wedge Press 6mm-St37

Kama Pres 6mm
Sheet Steel / Sac Çelik
0.110kg



B0584
Wedge Laser 6mm-St52

Kama Lazer 6mm
Sheet Steel / Sac Çelik
0.110kg



B0557
Ledger End

Kurtağzı
Malleable / Temper
0.370



B0628
Inter Connection

Ara Bağlantı
Ductile / Sfero
0.35kg



Cuplock Scaffolding Systems

Kamalı (Cuplock) İskele Sistemleri

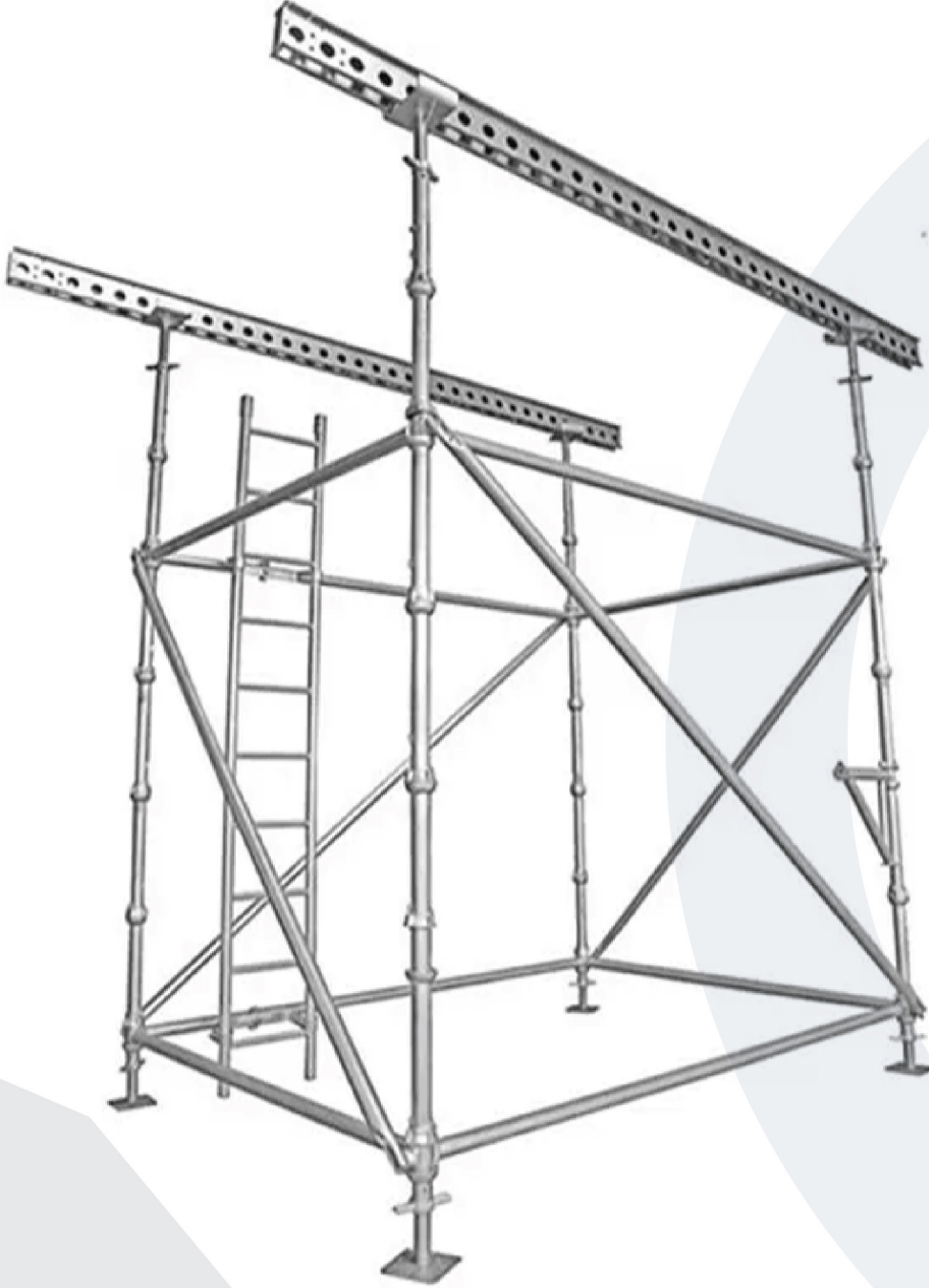

**B0581
Paddle**

Badem
Forged / Dövme
0.26kg

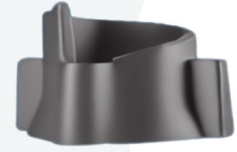

**B0582
Top Cup**

Üst Tas
Ductile / Sfero
0.45kg



**B0583
Bottom Cup**

Alt Tas
Sheet Metal / Sac
0.22kg



H Type (Modular) Scaffolding Systems

H Tipi (Modüler) İskele Sistemleri



B0476
Scaffolding Pin 18x55mm

İskele Pimi 18x55mm

Steel / Çelik

0.12kg



B0511
Scaffolding Pin Without Assembly 18x55mm

Montajsız Pim 18x55mm

Steel / Çelik

0.12kg



B0544
Wide Channel Pin 18x55mm

Geniş Kanallı Pim 18x55mm

Steel / Çelik

0.12kg

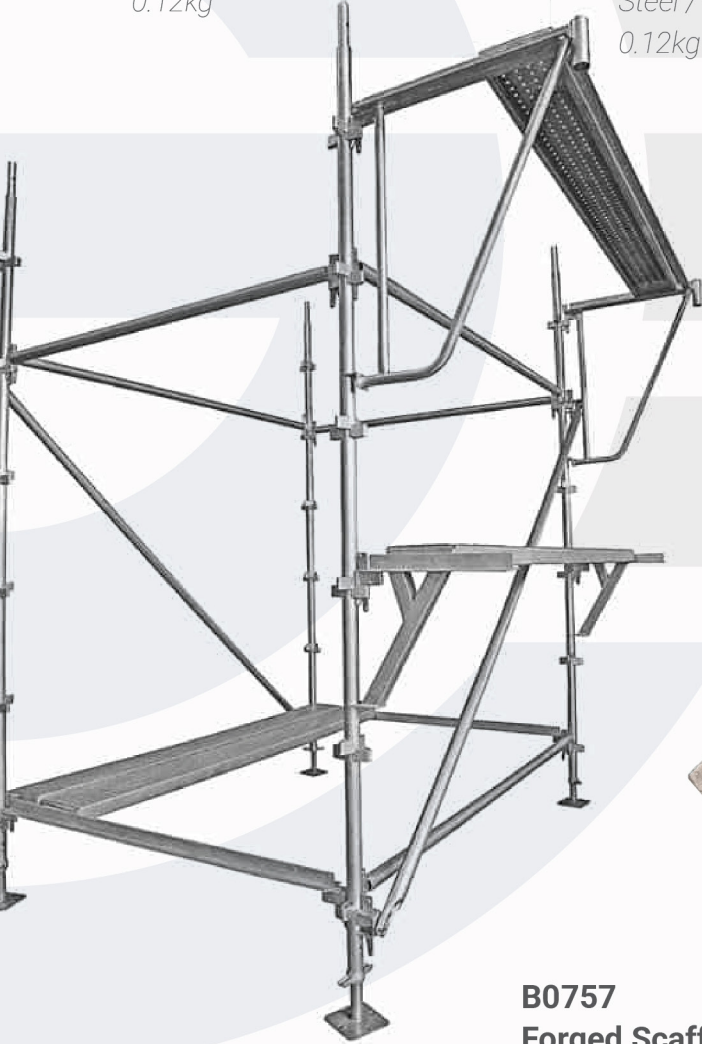

B0616
Forged Scaffold Pin 18x55mm

Dövme İskele Pimi 18x55mm

Forged / Dövme

0.12kg



B0757
Forged Scaffold Pin 19x60mm

Dövme İskele Pimi 19x90mm

Forged / Dövme

0.100kg



B0501
Forged Scaffold Pin 16x50mm

Dövme İskele Pimi 16x50mm

Steel / Çelik

0.10kg

Couplers Kelepçeler



B0057
Swivel Coupler 48x48mm
Hareketli Kelepçe 48x48mm
Forged / Dövme
1.13kg



B0058
Fix Coupler 48x48mm
Sabit Kelepçe 48x48mm
Forged / Dövme
1.1kg



B0082
Half Coupler 48mm
Tekli Kelepçe 48mm
Forged / Dövme
0.500kg



B0329
Girder Coupler
Kiriş Kelepçesi
Forged / Dövme
1.400kg



B0504
Putlog Coupler
Yaprak Kelepçe
Forged / Dövme
0.61kg



B0540
Sleeve Coupler
Boru Ekleme Kelepçesi
Forged / Dövme
1.05kg



B0580
Swivel Coupler 48x60mm
Hareketli Kelepçe 48x60mm
Forged Steel / Dövme Çelik
1.30kg

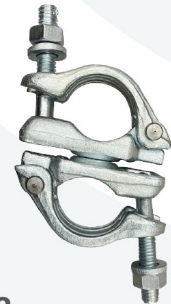

B0682
Swivel Coupler 60x60mm
Hareketli Kelepçe 60x60mm
Forged Steel / Dövme Çelik
1.50kg



Couplers

Kelepçeler

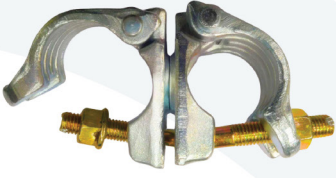

B0749
Swivel Coupler 48x48mm
German type

Hareketli Kelepçe 48x48mm
Alman tipi
Forged Steel / Dövme Çelik
1.25kg

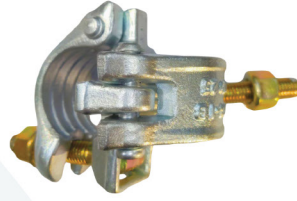

B0750
Fix Coupler 48x48mm
German Type

Sabit Kelepçe 48x48mm
Alman Tipi
Forged Steel / Dövme Çelik
1.2kg



B0751
Half Coupler 48mm
German Type

Tekli Kelepçe 48mm Alman Tipi
Forged Steel / Dövme Çelik
0.65kg

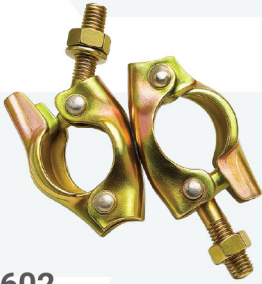

B0602
Pressed Swivel Coupler
48x48mm

Hareketli Sac Kelepçe
48x48mm
Sheet Metal / Sac Metal
0.99kg



B0662
Pressed Double Coupler
48x48mm

Sabit Sac Kelepçe 48x48mm
Sheet Metal / Sac Metal
0.825kg



B0688
Pressed Half Coupler 48mm

Tekli Sac Kelepçe 48mm
Sheet Metal / Sac Metal
0.48kg



B0719
Single Clamp 48mm Black

Tekli Kelepçe 48mm Siyah
Forged / Dövme
0.50kg



B0756
Board Retaining Clamp

Kalas Kelepçe
Forged / Dövme
0.650kg



B0755
Special Half Swivel

Yüzük Kelepçe
Forged / Dövme
0.600kg

Formwork Frame Panel Accessories

Kalıp Çerçeve Paneli Aksesuarları



B0529
Big Clamp Type 1
Pano Kelepçe Büyük
Ductile / Sfero
3.2kg



B0619
Small Clamp Type 1
Pano Kelepçe Küçük
Ductile / Sfero
1.3kg



B0715
Forged Big Clamp
Dövme Pano Kelepçe Büyük
Forged / Dövme
3.2kg



B0714
Long Adjustable Clamp
Type 2
Uzun Ayarlanabilir
Kelepçe Tip 2
Ductile / Sfero
5kg



B0585
Long Adjustable Clamp
Uzun Ayarlanabilir Kelepçe
Ductile+Steel/Sfero+Çelik
4.50kg



B0606
A Type Clamp
A Tipi Kelepçe
Steel / Çelik
5.8kg



B0732
Long Adjustable Clamp
Type 3
Uzun Ayarlanabilir Kelepçe Tip 3
Ductile / Sfero
3.23kg



B0555
P Type Clamp
P Tipi Kelepçe
Steel / Çelik
4.40kg



Projeye uygun, sahada güçlü.

Optimized for your project requirements, reliable in demanding jobsite conditions.

Formwork Frame Panel Accessories

Kalıp Çerçeve Paneli Aksesuarları



B0687

Corner Head

Köşe Birleştirme Takozu

Malleable Casting/

Temper / Döküm

1.1kg

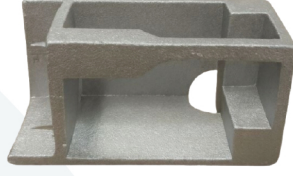

B0640

Corner Head Type 1

Köşe Takoz Type 1

Ductile / Sfero

1.22kg

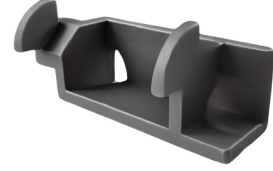

B0569

Corner Head Type 2

Köşe Takoz Type 2

Ductile/Sfero

0.24kg

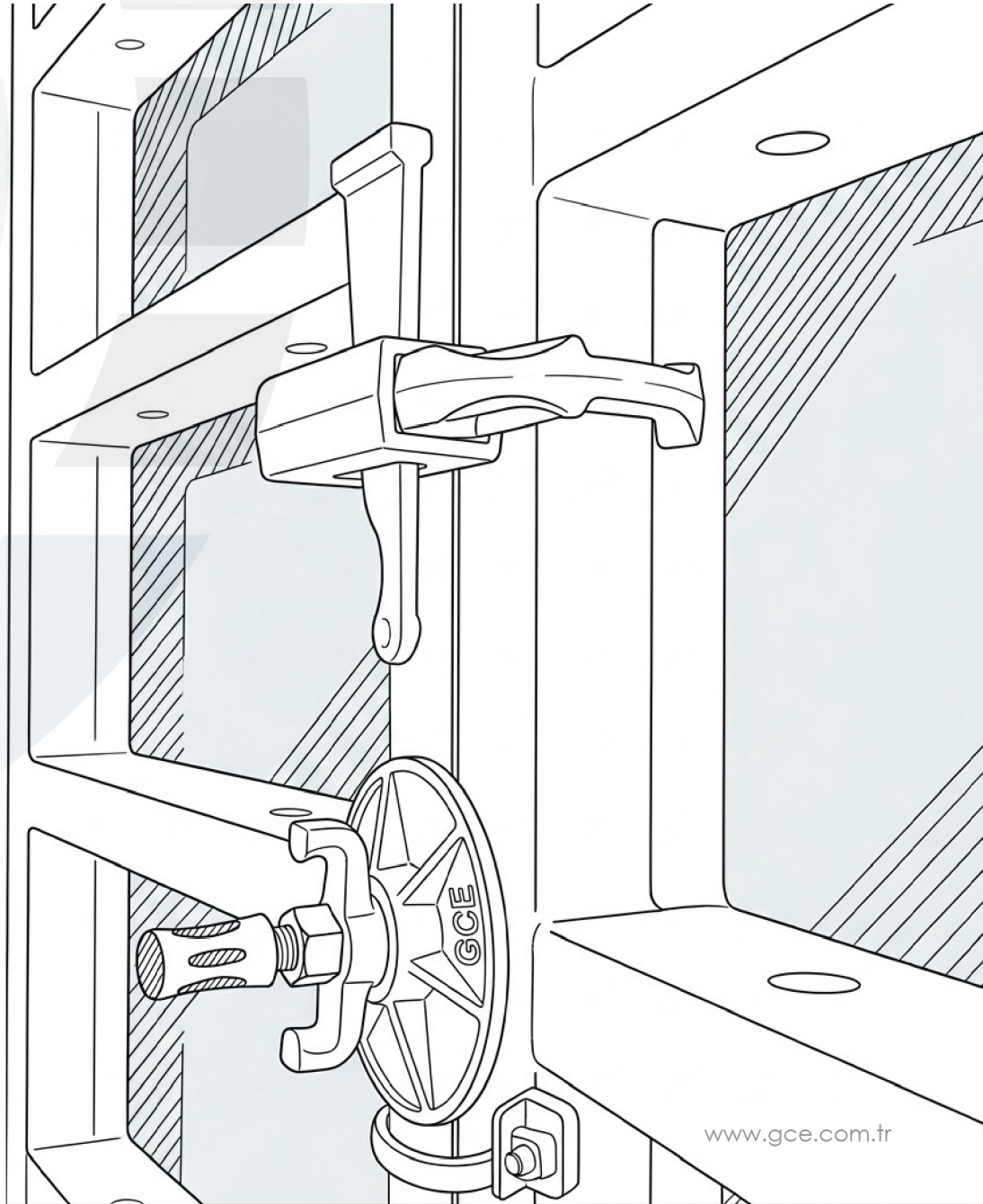

Base Head Jacks

Taban Başı Krikolar



B0537
Jack Nut 35mm
Ayar Mili Somunu 35mm
Ductile / Sfero
0.38kg



B0333
Jack Nut 38mm
Ayar Mili Somunu 38mm
Ductile / Sfero
0.40kg



B0538
Jack Nut 40mm
Ayar Mili Somunu 40mm
Ductile / Sfero
0.42kg



B0324
Jack Nut 48mm (Without Thread)
Ayar Mili Somunu 48mm
(Diş Açılmamış)
Ductile / Sfero
0.98kg

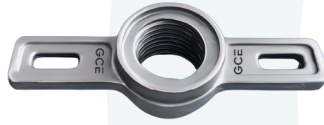

B0411
Jack Nut 48mm (Threaded)
Ayar Mili Somunu 48mm
(Diş Açılmış)
Ductile / Sfero
0.97kg



B0651
Threaded Tube 48mm
Ayar Vidası 48mm
Steel / Çelik
5.0kg

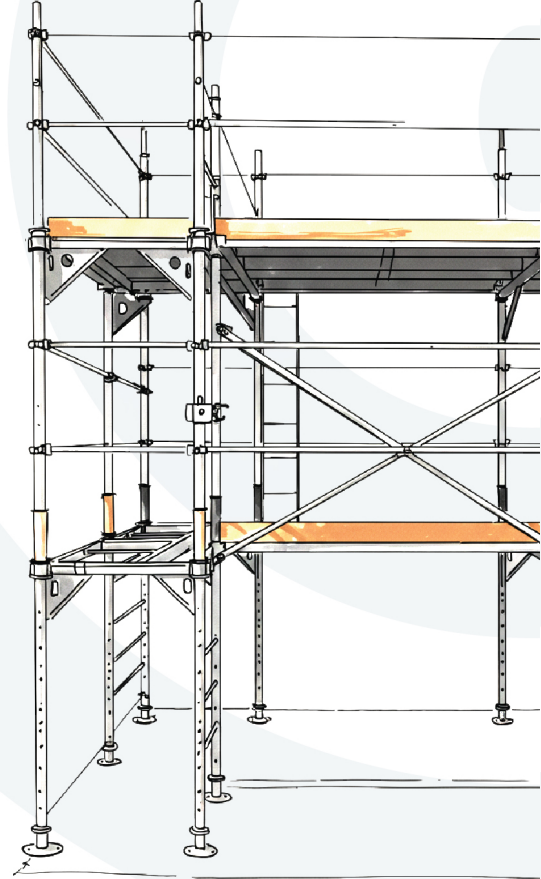

Base Head Jacks

Taban Başı Krikolar



B0645

Base Jack 35x50cm

Ayar Mili Takımı 35x50cm

Ductile / Sfero

Please Ask!



B0646

Base Jack 35x75cm

Ayar Mili Takımı 35x75cm

Ductile / Sfero

Please Ask!



B0647

Base Jack 35x100cm

Ayar Mili Takımı 35x100cm

Ductile / Sfero

Please Ask!



B0417

Base Jack 38x50cm

Ayar Mili Takımı 38x50cm

Ductile / Sfero

2.70kg



B0513

Base Jack 38x75cm

Ayar Mili Takımı 38x75cm

Ductile / Sfero

3.50kg



B0587

Base Jack 38x100cm

Ayar Mili Takımı 38x100cm

Ductile / Sfero

4.25kg



B0648

Base Jack 40x50cm

Ayar Mili Takımı 40x50cm

Ductile / Sfero

Please Ask!



B0649

Base Jack 40x75cm

Ayar Mili Takımı 40x75cm

Ductile / Sfero

Please Ask!



B0650

Base Jack 40x100cm

Ayar Mili Takımı 40x100cm

Ductile / Sfero

Please Ask!

Slope Nut&Forged Bars

Eğimli Somun Ve Dövme Çubuklar



B0323

Slope Nut 120 15-17

Taban Plakalı Çatal Somun
120 15-17

Ductile+Steel / Sfero+Çelik
1.10kg



B0512

Slope Nut 140 15-17

Taban Plakalı Çatal Somun
140 15-17

Ductile+Steel / Sfero+Çelik
1.33kg



B0630

Slope Nut 140 20-22

Taban Plakalı Çatal Somun
140 20-22

Ductile+Steel / Sfero+Çelik
1.78kg



B0631

Slope Nut 140 20-36

Taban Plakalı Çatal Somun
140 20-36

Ductile+Steel / Sfero+Çelik
1.88kg



B0656

Flat Tie Rod Mil 6m

Yassı Tierot Mili 6m
*Yüksek Dayanımlı Çelik /
High-Strength Steel*
9kg



B0369

Straight Tierot Mil 3m

Ovalama (Düz) Tierot Mil 3m
Steel / Çelik
4.2kg



Slope Nut&Forged Bars

Eđimli Somun Ve Dövme Çubuklar



B0315
Tierot Nut 90 mm Type 1
 Tierot Somunu 90 mm Tip 1
 Ductile / Sfero
 0.420kg



B0334
Tierot Nut 90 mm Type 2
 Tierot Somunu 90 mm Tip 2
 Ductile / Sfero
 0.450kg



B0710
Tierot Nut 90 mm Type 3
 Tierot Somunu 90 mm Tip 3
 Ductile / Sfero
 0.540kg



B0330
Tierot Nut 100 mm
 Tierot Somunu 100 mm
 Ductile / Sfero
 0.655kg



B0314
Waler Wing Nut 70mm
 Tierot Somunu 70mm
 Ductile / Sfero
 0.28kg



B0722
T Tierot Forged Bar Type 2 335mm
 T Tierot Dövme Bar Tip 2 335mm
 Forged / Dövme
 0.67kg

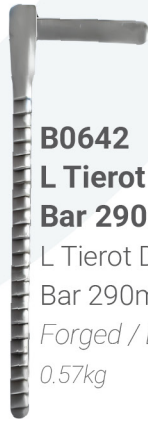

B0642
L Tierot Forged Bar 290mm
 L Tierot Dövme Bar 290mm
 Forged / Dövme
 0.57kg



B0643
T Tierot Forged Bar 330mm
 T Tierot Dövme Bar 330mm
 Forged / Dövme
 0.62kg



B0644
T Tierot Forged Bar 335mm
 T Tierot Dövme Bar 335mm
 Forged / Dövme
 0.65kg

Other Formwork

Diğer Kalıplar



B0632
Panel Lock 8mm

Kalıp Kilidi 8mm
Ductile / Sfero
0.55kg



B0633
Panel Lock 10mm

Kalıp Kilidi 10mm
Ductile / Sfero
0.45kg

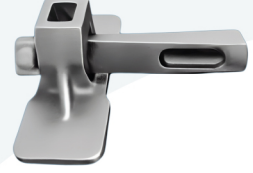

B0634
Rapid Clamp

Kamalı Döküm Çiroz
Ductile / Sfero
0.400kg



B0502
Tension Jack

Sac Yaylı Çiroz
Sheet Metal / Sac
0.50kg



B0635
Formwork Pin Wedge

Kalıp Pimi Kaması
Sheet Metal / Sac
0.06kg



B0636
Formwork Pin

Kalıp Pimi
Malleable / Temper
0.110kg

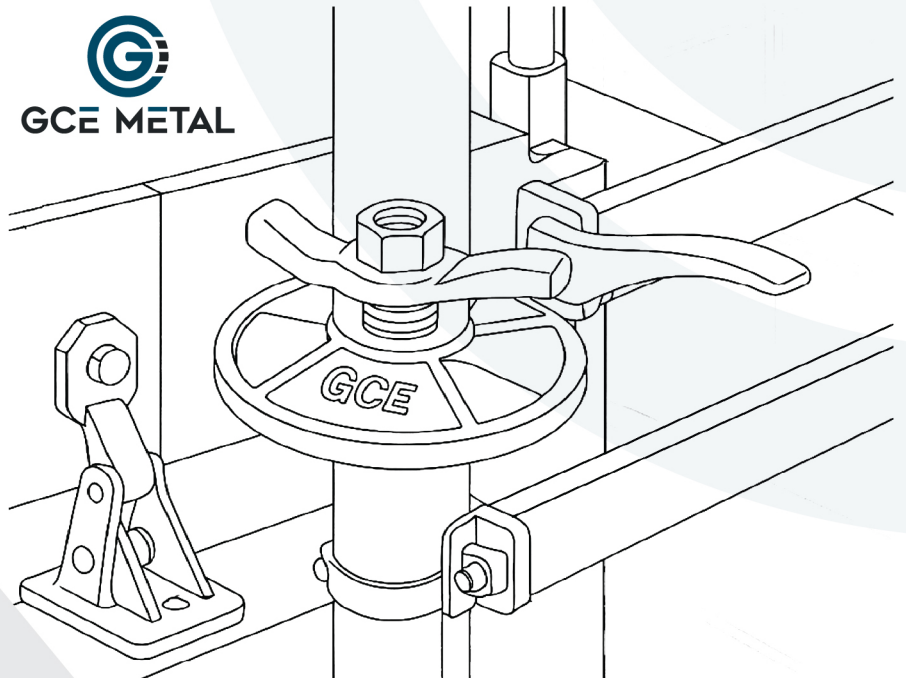

Gelişim bizim için bir tercih değil, bir görevdir.

Progress is not an option - it's our mission.

Water Stops

Su Tutucu

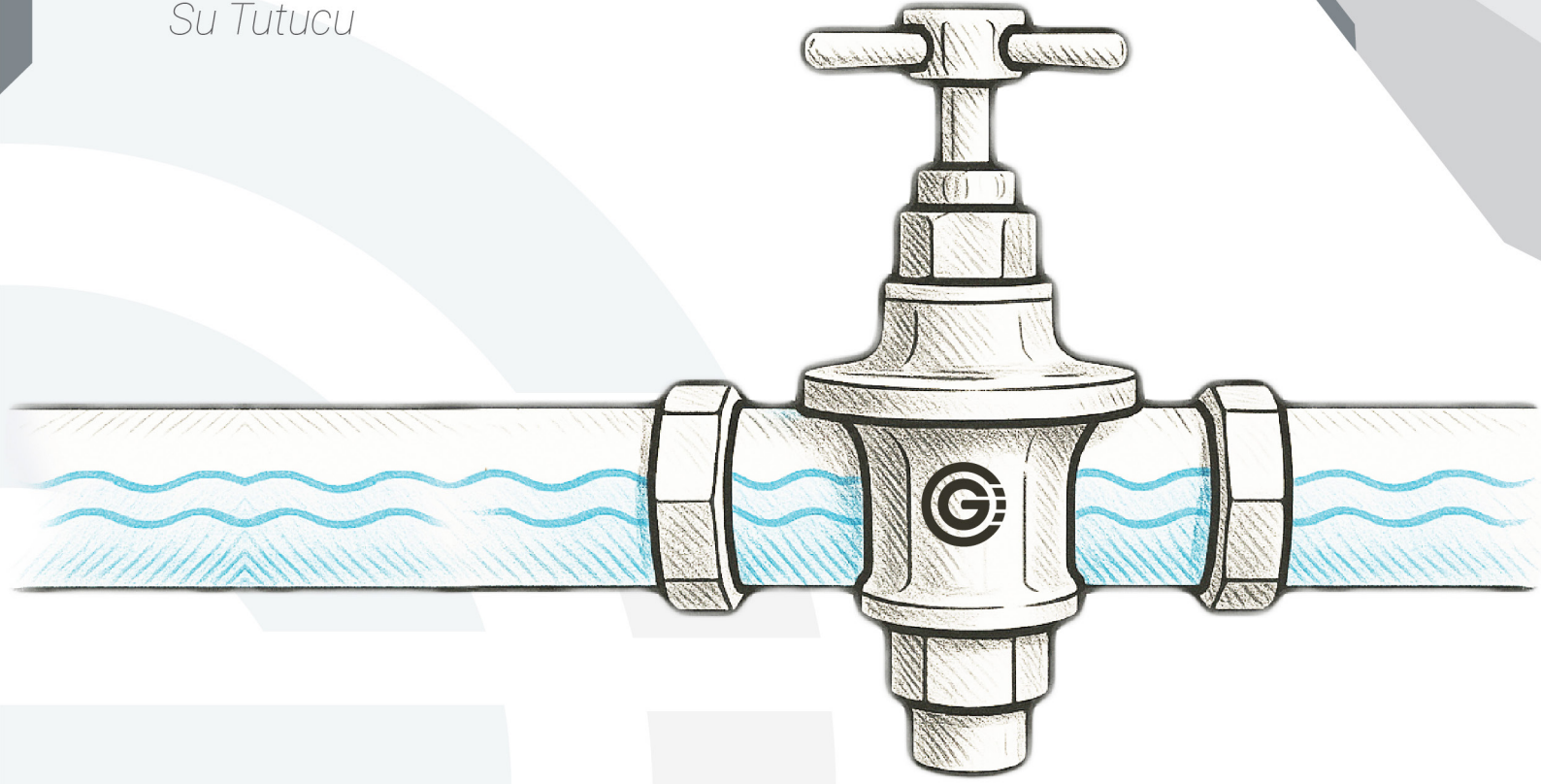

B0639

Water Stopper

Bağumlu Su Tutucu

Ductile / Sfero

0.41kg



B0337

Water Stopper 17mm

Flanşlı Su Tutucu 17mm

Ductile / Sfero

0.49kg



B0638

Water Stopper 24mm

Flanşlı Su Tutucu 24mm

Ductile / Sfero

1.21kg

Prop Nuts Somunlar



B0528

Mechanism Nut 60mm

Mekanizma Somunu 60mm

Ductile / Sfero

0.44kg



B0542

Mechanism Nut 76mm

Mekanizma Somunu 76mm

Ductile / Sfero

0.67kg



B0424

Threaded Tube 60x3

Mekanizma Borusu 60x3

Steel / Çelik

0.78kg



B0623

Threaded Tube 76mm

Mekanizma Borusu 76mm

Steel / Çelik

1.20kg



B0475

Prop Sleeve 60x3

Takim Mekanizma 60x3

Ductile / Sfero

1.400kg

B0586

**Mecahism Nut 60mm
With Handle 14mm**

Mekanizma Somunu 60mm

Kulplu 14mm

Ductile / Sfero

0.72kg



B0624

**Mecahism Nut 76mm
With Handle 14mm**

Mekanizma Somunu 76mm

Kulplu 14mm

Ductile / Sfero

0.95kg



Prop Nuts

Somunlar



B0625
Prop Sleeve 76mm
Takım Mekanizma 76mm
Ductile / Sfero
1.400kg



B0626
Prop Nut 60mm-062
Somunlar 60mm-062
Ductile/Sfero
1.72kg

Pins

Pimler

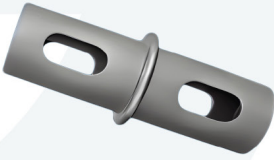

B0566
Nipple Pipe Insertion
Nipel Boru Ekleme
Steel / Çelik
0.44kg

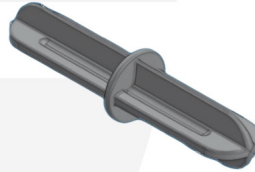

B0620
Pipe Insertion Pin
Boru Ekleme Pin
Ductile / Sfero
0.57kg



B0540
Sleeve Coupler
Boru Ekleme Kelepçesi
Steel / Çelik
1.05kg



Timber Beam Formwork Accessories

Ahşap Kiriş Kalıp Aksesuarları



B0483
Support Head

Payanda Kafası
Ductile / Sfero
2.20kg



B0481
Corner Head

Köşe Bağlantı Parçası
Ductile / Sfero
2.40kg



B0482
H20 Klips

H20 Klips
Ductile / Sfero
0.77kg



B0657
Wedge 19.5mm

Kama 19.5mm
Ductile / Sfero
0.75kg



B0480
Wedge 19.5mm

Kama 19.5mm
Ductile / Sfero
0.75kg



B0621
Support Head Wedge

Payanda Kafası Kaması
Steel / Çelik
0.38kg



Timber Beam Formwork Accessories

Ahşap Kiriş Kalıp Aksesuarları



B0753
Clevis Pin With Hairpin
Short 16x60

Firketeli Pim Kısa 16x60
Steel / Çelik
0.12kg



B0561
Clevis Pin With Hairpin
16x80

Firketeli Pim 16x80
Steel / Çelik
0.16kg



B0752
Clevis Pin With Hairpin
Long 16x120

Firketeli Pim Uzun 16x120
Steel / Çelik
0.22kg



B0664
Cotter Pin
Firkete (Kopilya)

Steel / Çelik
0.020kg



B0716
Big Formwork Hook
Büyük Kalıp Kancası

Forged / Dövme
10.5kg



B0484
Hook Set
Kanca Takım

Ductile/Sfero
0.90kg



B0498
Right Hook

Sağ Kanca
Ductile / Sfero
0.25kg



B0499
Left Hook

Sol Kanca
Ductile / Sfero
0.25kg

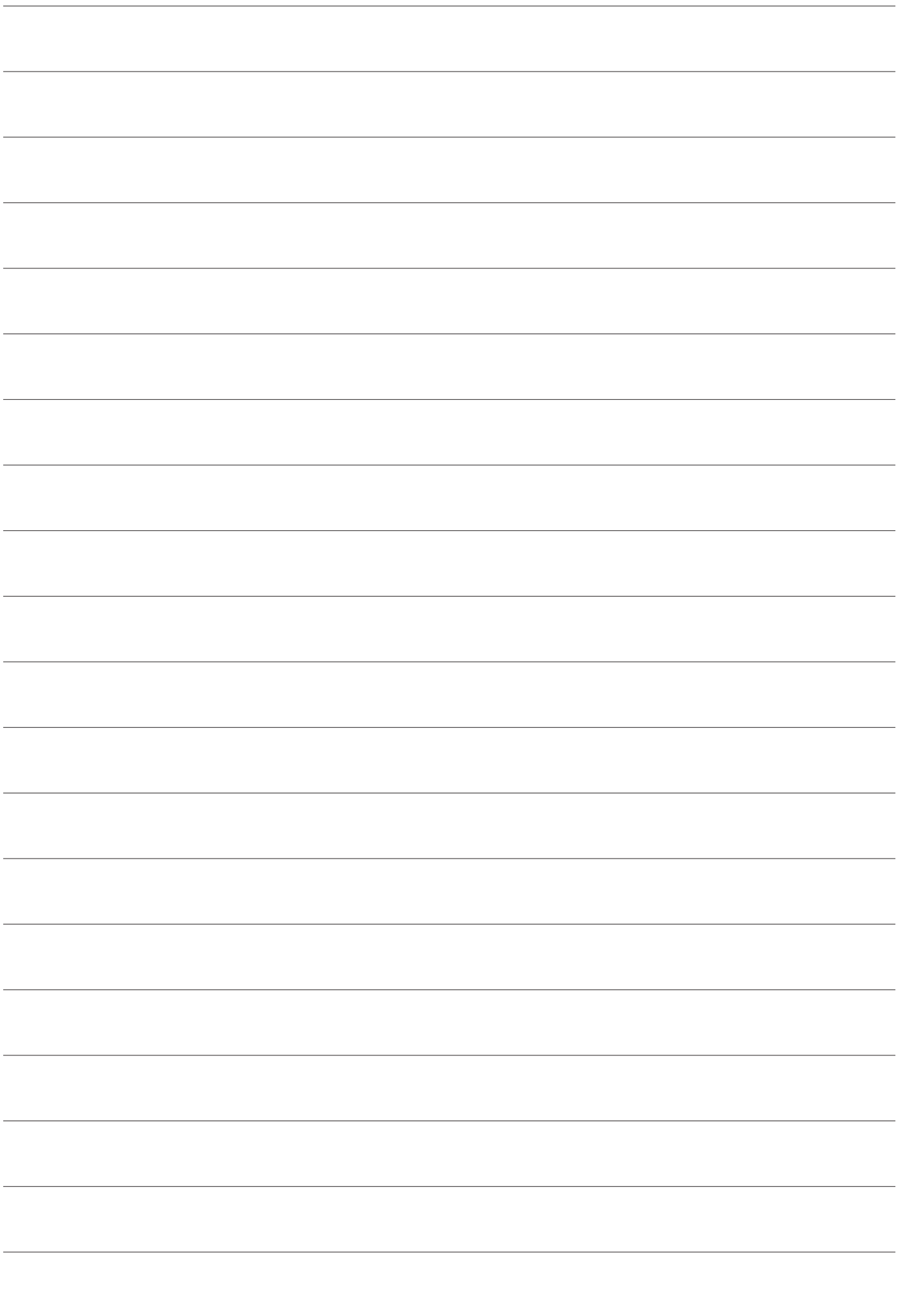



GCE METAL

Pelitli Mah. Yeni Mezarlık Yolu Cad. 
No:64/1 Gebze / Kocaeli / Türkiye

+90 (534) 575 28 92 

+90 (534) 575 28 92 

satis@gce.com.tr 

@gcemetal 

gce-metal 

www.gce.com.tr 